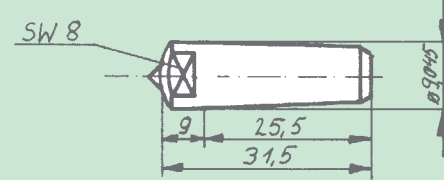
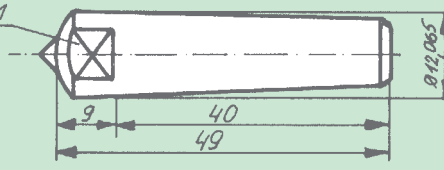
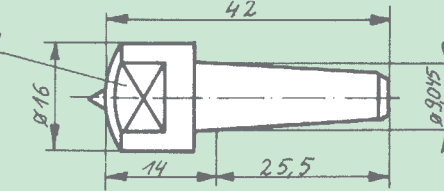
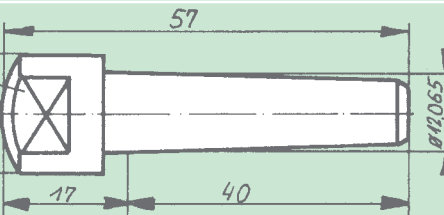
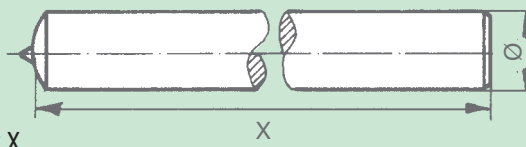

<p>2a</p> <p>Einkorn- Abricht- Diamanten Fassung MK</p> <p>Single Grain Dressing Diamonds Mounting MK</p> <p>Monocrystal Diamants de Dressage Monture MK</p>	Best. Nr./No.	Fassung	Lieferbare Karat	
	A 100	MK 0		0,10 0,30 0,50 0,75 1,00
	A 105	MK 1		0,10 0,30 0,50 0,75 1,00 1,50 2,00
	A 110	MK 0		0,10 0,30 0,50 0,75 1,00 1,50 2,00
	A 115	MK 1		0,10 0,30 0,50 0,75 1,00 1,50 2,00

<p>2b</p> <p>Einkorn- Abricht- Diamanten Fassung Form D</p> <p>Single Grain Dressing Diamonds Mounting Shape D</p> <p>Monocrystal Diamants de Dressage Monture Forme D</p>			Lieferbare Karat
	A 225	6 x 30	0,10,300,50
	A 230	6 x 50	0,10,300,50
	A 235	6 x 80	0,10,300,50
	A 240	6 x 100	0,10,300,50
	A 245	6 x 150	0,10,300,50
	A 170	8 x 30	0,10,300,50,0,75 1,00
	A 250	8 x 50	0,10,300,50,0,75 1,00
	A 220	8 x 90	0,10,300,50,0,75 1,00
	A 255	8 x 150	0,10,300,50,0,75 1,00
	A 275	10 x 30	0,10 0,30 0,50 0,75 1,00 1,50 2,00
	A 280	10 x 60	0,10 0,30 0,50 0,75 1,00 1,50 2,00
	A 285	10 x 150	0,10 0,30 0,50 0,75 1,00 1,50 2,00
	A 260	12 x 30	0,10 0,30 0,50 0,75 1,00 1,50 2,00
	A 265	12 x 50	0,10 0,30 0,50 0,75 1,00 1,50 2,00
	A 270	12 x 150	0,10 0,30 0,50 0,75 1,00 1,50 2,00

2c

Einkorn- Abriht- Diamanten Fassung Jung Kegel

Single Grain
Dressing Diamonds
Mounting
Jung Cone

Monocrystal
Diamant de Dressage
Monture
Cône Jung

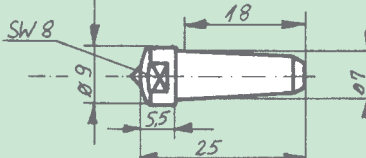
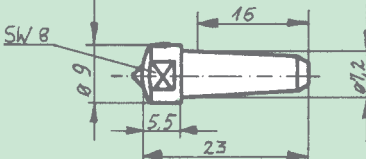
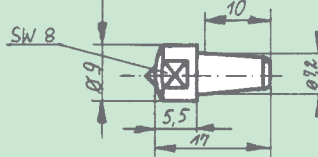
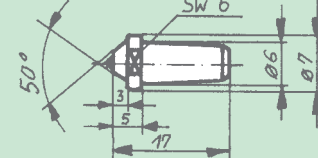
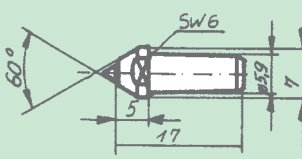
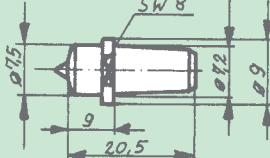
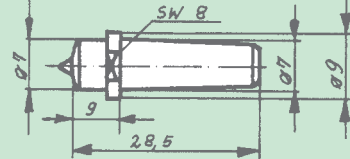
Best. Nr. / No.	Fassung	Lieferbare Karat
A130	Jung Kegel 1:20 	0,10 0,75 0,30 1,00 0,50
A135	Jung Kegel 1:13, 15 	0,10 0,75 0,30 1,00 0,50
A140	Jung Kegel 1:13, 15 	0,10 0,75 0,30 1,00 0,50
A150	Jung Kegel 1:10 	0,10 0,30 0,50 0,75
A175	Jung Kegel 1:10 	0,10 0,30 0,50 0,75
A180	Jung Kegel 1:13, 15 	0,10 0,30 0,50 0,75
A185	Jung Kegel 1:20 	0,10 0,30 0,50 0,75

2d

Einkorn- Abriht- Diamanten Sonstige

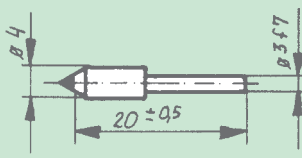
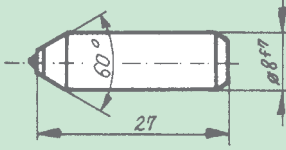
A120	Form C 	0,10 0,15 0,20
A125	Form D 	0,10 0,75 0,30 1,00 0,50

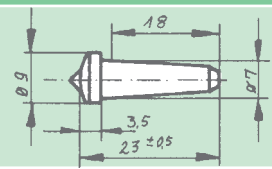
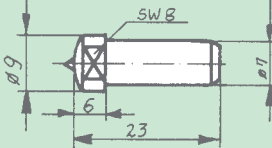
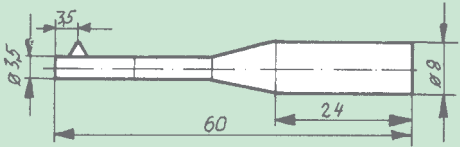
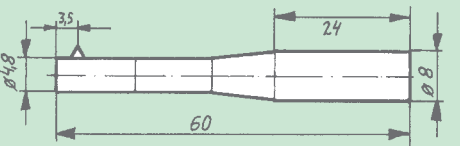
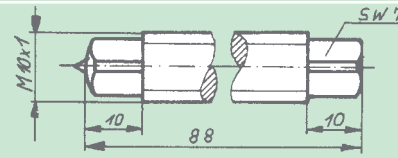
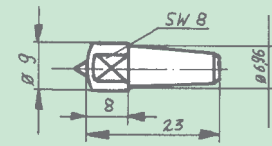
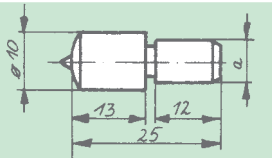
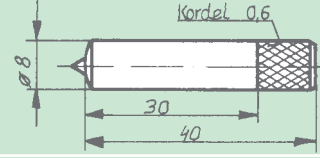
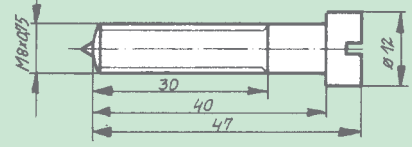
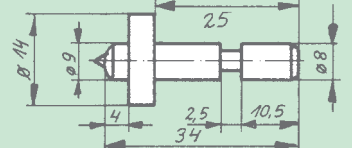
<p>2d</p> <p>Einkorn- Abricht- Diamanten Sonstige</p> <p>Single Grain Dressing Diamonds Others</p> <p>Monocrystal Diamants de Dressage Autres</p>	Best. Nr./No.	Fassung	Lieferbare Karat	
	A 145	Form E		0,10 0,30 0,50 0,75
	A 155	Kolb Kegel 1:50		0,10 0,30 0,50 0,75
	A 160	ABA		0,10
	A 165	ABA		0,10 0,30
	A 190	Niles		0,10 0,30 0,50 0,75
	A 195	Kolb		0,10 0,30 0,50 0,75
	A 200	Landis	 <p>a = ø 6 ø 6,5 ø 8</p>	0,10 0,30 0,50 0,75
	A 205	Jung		0,10 0,30 0,50 0,75
	A 210	Niles		0,10 0,30 0,50 0,75
A 215	Nomoko		0,10 0,30 0,50 0,75	